



珠海市鹏辉电池有限公司
Great Power Battery Co.,Ltd

Product Specification

Battery Type: LIR 2016

Battery Specification: 3.7V/12mAh

Customer confirmation: _____

Note:1.Kindly please sign on the above and send it back to us if the sample is approved.
2.Kindly please contact us as soon as possible if the sample isn't approved. Thanks!

Document NO.		Date	
Edition		Page	6 Page
Approved		Checked	Design



---CONTENTS---

1. SCOPE.....	Page2
2. BATTERY PACK SPECIFICATION.....	Page2
3. STANDARD TEST CONDITIONS.....	Page2
4. APPEARANCES.....	page3
5. ELECTRICAL CHARACTERISTICS.....	page3
6. TEMPERATURE ADAPTABILITY.....	page3
7. DESTROY ADAPTABILITY.....	page4
8. CAUTIONS IN USE.....	page4
9. Dimension	page5



1. SCOPE

This specification describes the related technical standard and requirements of the rechargeable Li-ion battery pack supplied by Great power Battery (Zhuhai) Co., Ltd. Battery produced with the LIR2016 cell will meet the specification.

2. BATTERY SPECIFICATION

ITEMS	SPECIFICATION		REMARK
Model	LIR 2016		
Constant Voltage	3.7V		
Capability	Typical	12mAh	@0.2C Discharge
	Minimum	10mAh	
Dimensions	$\Phi 20.0(\pm 0.3)*1.6(+0.3)$ mm		Bare cell
Weight	1.6(± 0.2) g		

3. STANDARD TESTING CONDITIONS (No Load)

ITEMS	REGISTER		
Standard charge	CC/CV model, constant voltage 4.2V, constant current 0.2C, end current 0.01C		
General charge.	CC/CV model, constant voltage 4.2V, constant current 0.5C, end current 0.01C		
Apace charge	CC/CV model, constant voltage 4.2V, constant current 1C, end current 0.01C		
Standard discharge	Constant current 0.2C, end voltage 2.75V		
General discharge	Constant current 0.5C, end voltage 2.75V		
Apace discharge	Constant current 1C, end voltage 2.75V		
Environment temperature	Charge	0 -- +45°C	
	Discharge	-20°C -- +60°C	
	Storage temperature	One month	-20°C -- +55°C
		Three months	-20°C -- +45°C
		One year	-5°C -- +30°C
	General temperature	20°C \pm 5°C	
	Atmospheric pressure	86 -- 106Kpa	
Relative humidity	45% -- 85%		



4. APPEARANCES

ITEMS	TEST CONDITION	REQUIRE
APPEARANCE	Under light lamp 40W	Shall be free noticeable flaws breaks, age, Discoloration, deformation, uneven, and other Defects which impair the value of the commodity

5. ELECTRICAL CHARACTERISTICS

ITEMS	TEST CONDITION	REQUIRE
Complete Charge	The battery is charged with constant current 0.2CmA and constant voltage 4.2v until the charging current is less than 0.01CmA. The longest charging time is less than 8 hours.	
Initial capacity	The capacity measured after the battery is discharged with constant current 0.2C until the voltage reaches 2.75V cut-off in one hour after complete charge.	12mAh
Cycle life	The capacity measured after 500 cycles of complete charge and discharge at 0.2C current to 2.75V cut-off.	Capacity more than 70% of Initial capacity
Impedance	Internal resistance measured at 1KHz after complete charge.	$\leq 2000m\Omega$

6. TEMPERATURE ADAPABILITY

ITEMS	TEST CONDITION	REQUIRE
High temperature discharge	After complete charge, at 60°C , discharging current 0.2C to 2.75V-END discharge.	No explosion, fire, or smoke. Discharge efficiency $\geq 85\%$.
High temperature exposure	After relative charge, all batteries being tested are stored in chamber of 150°C for 10 min. After taking the batteries out of the chamber, all the batteries are visually examined.	No explosion, fire, or smoke.
Low temperature discharge	After complete charge. At -20°C, discharging current 0.2CmA to 2.75V-END discharge.	No explosion, fire, or smoke. Discharge efficiency $\geq 80\%$.



7. DESTROY ADAPTABILITY

ITEMS	TEST CONDITION	REQUIRE
Vibration Test	Subject to 1 hour 10-55Hz 3.5mm amplitude Vibration for any direction at shipment (complete packing) state. Then test discharge and rated charge at $25\pm 2^{\circ}\text{C}$.	No explosion, fire or Smoke. No leakage or damage
Drop Test	Drop test battery 1.2m above steel board of more than 10mm thickness. One time drop each for 6 surface, 4 ride direction of a battery pack	No leakage or damage No explosion, fire or Smoke. Discharge time Less than 50 minute.

8. CAUTIONS IN USE

To ensure proper use of the battery please read the manual carefully before using it.

. Handling

- Do not expose to, dispose of the battery in fire.
- Do not put the battery in a charger or equipment with wrong terminals connected.
- Avoid shorting the battery
- Avoid excessive physical shock or vibration.
- Do not disassemble or deform the battery.
- Do not immerse in water.
- Do not use the battery mixed with other different make, type, or model batteries.
- Keep out of the reach of children.

. charge and discharge

- Battery must be charged in appropriate charger only.
- Never use a modified or damaged charger.
- Do not leave battery in charger over 24 hours.

. storage

- Store the battery in a cool, dry and well-ventilated area.

. disposal

- Regulations vary for different countries. Dispose of in accordance with local regulations.



9. Dimension

Edition NO.	Date	Sign	Checked

(一)

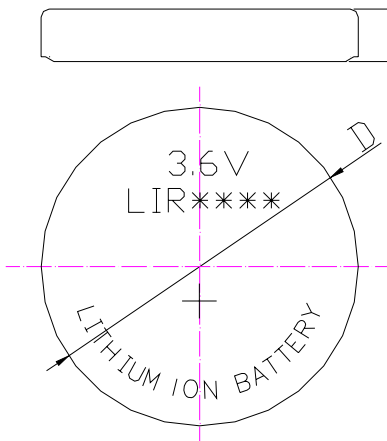

(二)

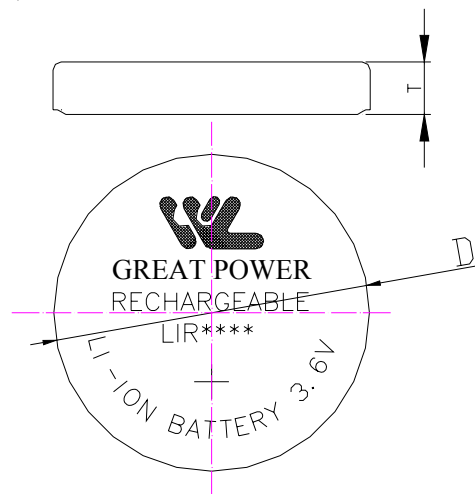

D	20.0±0.3	T	1.6+0.3	UNIT	mm
Drawer		Checked		Approved	Date
GREAT POWER			LIR 2016 DRAWING		
			Drawing ID		